

RA 400 E
Pushbar 1

As at: 05/27/08 Time:05:26

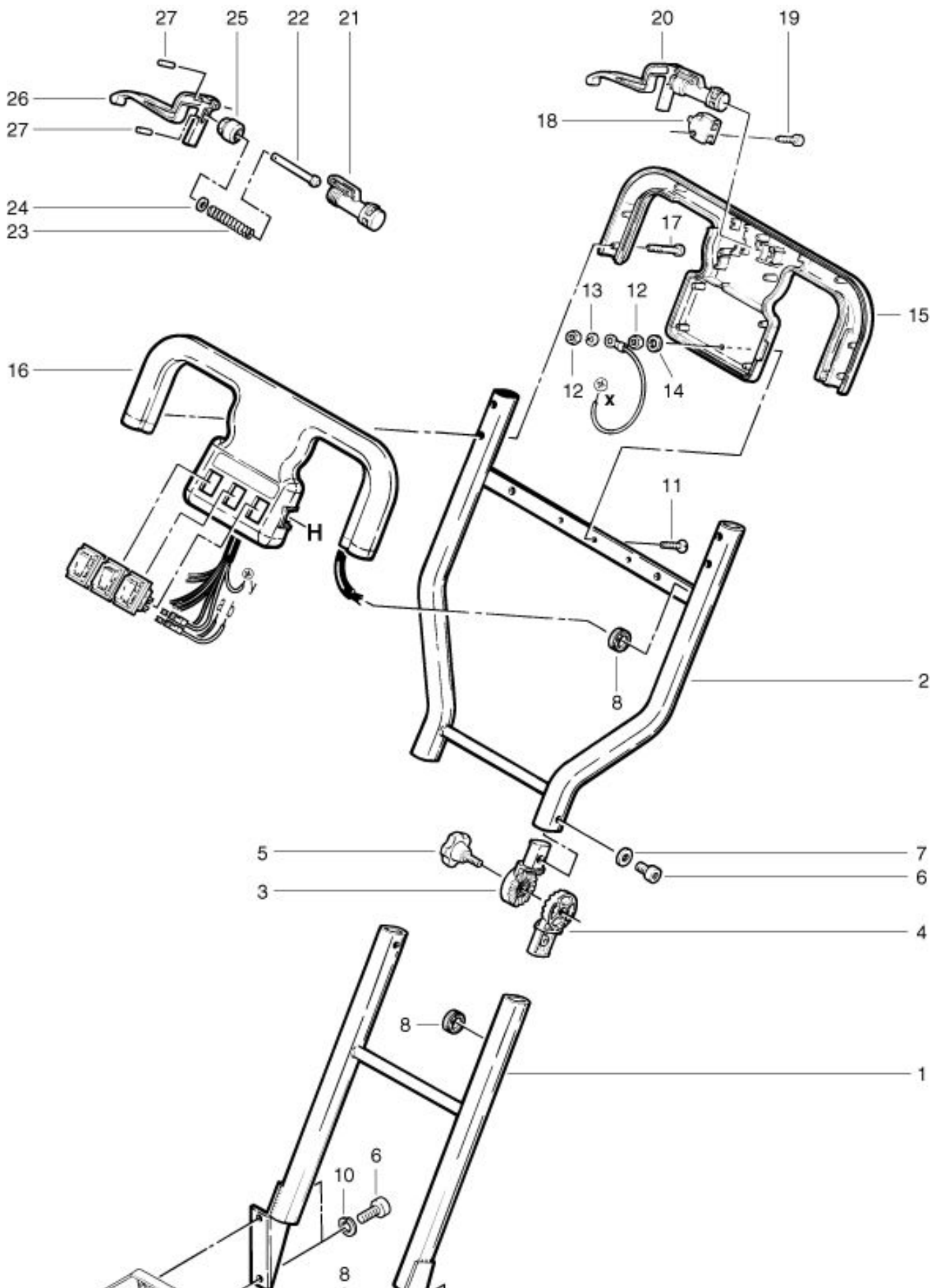

RA 400 E

Pushbar 1

As at: 05/27/08 Time:05:26

Pos.	Description	Reference
01	Lower pushbar	400.652
02	Upper pushbar	420.650
03	Upper joint	420.601
04	Lower joint	420.602
05	Screw knob	P...253
06	Hexagon socket screw M 6x12 mm	P...486Q
07	Washer M6	P...496L
08	Rubber clamp	P...207A
10	Spring ring M6	P...498U
11	Screw M 4x20 mm	P...481E
12	Hexagon nut M4	P...491Q
13	Spring ring M4	P...498A
14	Washer M4	P...496C
15	Lower handle housing	400.615
16	Upper handle housing	400.611
17	PT screw KA 30x30 mm	P...516B
18	Switch	P...242
19	PT screw KA 30x20 mm	P...516E
20	Lever complete including Items 21-27	400.620
21	Valve body	400.622
22	Valve pin	P...681D
23	Valve spring	P...681E
24	Washer M5	P...497G
25	Cap nut	P...681B
26	Lever	400.621
27	Cyl. Pin dm 1,5x14,5 mm	P...681K